

Surface Mount Superfast Recovery Rectifier
Reverse Voltage 850 to 600 V
Forward Current 5 A

FEATURES

- "For surface mounted applications
- " Low profile package
- " Glass Passivated Chip Junction
- " Superfast reverse recovery time
- " Lead free in comply with EU RoHS 2011/65/EU directives

MECHANICAL DATA

- "Case : SMC
- " Terminals: Solderable per MIL-STD-750, Method 2026
- "A pprox. Weight : 0.22g / 0.0077oz

PINNING

PIN	DESCRIPTION
1	Cathode
2	Anode

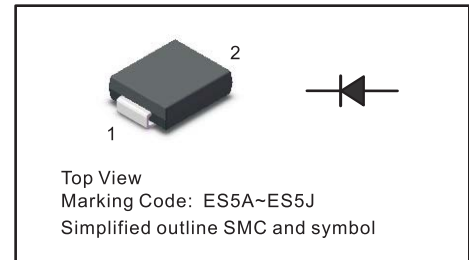

Absolute Maximum Ratings and Characteristics

Ratings at 25 °C ambient temperature unless otherwise specified. Single phase, half wave, 60 Hz, resistive or inductive load. For capacitive load, derate current by 20%.

Parameter	Symbols	ES5AC	ES5BC	ES5CC	ES5DC	ES5EC	ES5GC	ES5JC	Units
Maximum Repetitive Peak Reverse Voltage	V_{RRM}	50	100	150	200	300	400	600	V
Maximum RMS voltage	V_{RMS}	35	70	105	140	210	280	420	V
Maximum DC Blocking Voltage	V_{DC}	50	100	150	200	300	400	600	V
Maximum Average Forward Rectified Current at $T_c = 100\text{ }^\circ\text{C}$	$I_{F(AV)}$	5							A
Peak Forward Surge Current 8.3 ms Single Half Sine Wave Superimposed on Rated Load	I_{FSM}	120							A
Maximum Forward Voltage at 5 A	V_F	1				1.25		1.68	V
Maximum DC Reverse Current at Rated DC Blocking Voltage $T_a = 25\text{ }^\circ\text{C}$ $T_a = 125\text{ }^\circ\text{C}$	I_R	5 100							%A
Typical Junction Capacitance at $V_R=4\text{V}$, $f=1\text{MHz}$	C_j	50							pF
Maximum Reverse Recovery Time ¹	t_{rr}	35							ns
Typical Thermal Resistance ²	$R_{\theta JA}$ $R_{\theta JC}$	35 13							$^\circ\text{C/W}$
Operating and Storage Temperature Range	T_j, T_{stg}	-55 ~ +150							$^\circ\text{C}$

¹ Measured with $I_F = 0.5\text{ A}$, $I_R = 1\text{ A}$, $I_{rr} = 0.25\text{ A}$.

² P.C.B. mounted with 2.0" X 2.0" (5 X 5 cm) copper pad areas.

Fig.1 Reverse Recovery Time Characteristic And Test Circuit Diagram

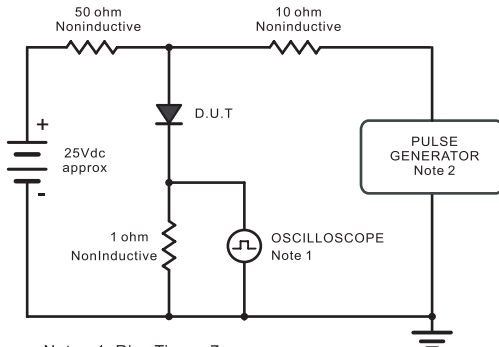

Note 1. Rise Time = 7ns, max.
Input Impedance = 1 megohm, 22pF.
2. Rise Time = 10ns, max.
Source Impedance = 50 ohms.

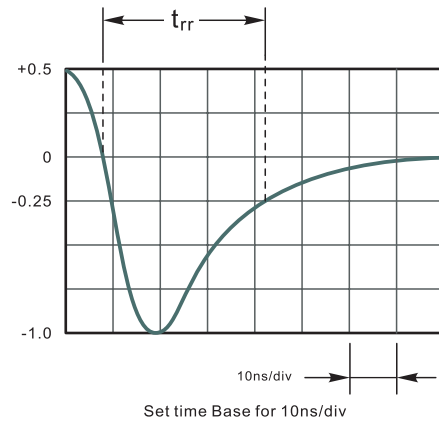

Fig.2 Maximum Average Forward Current Rating

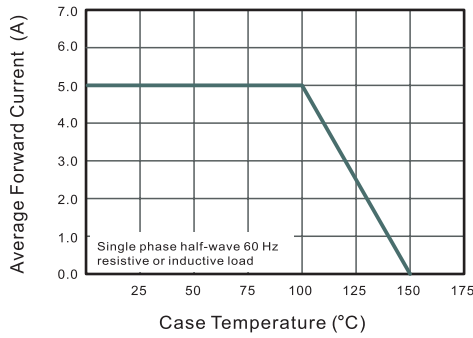

Fig.3 Typical Reverse Characteristics

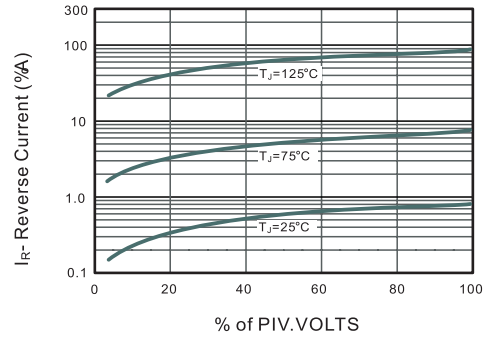

Fig.4 Typical Forward Characteristics

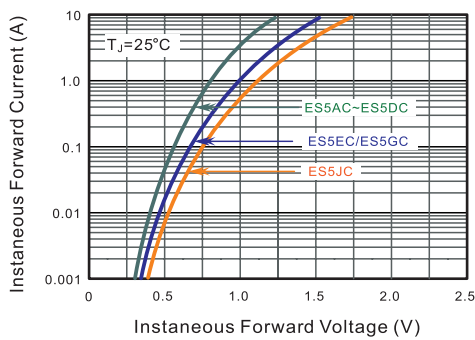

Fig.5 Typical Junction Capacitance

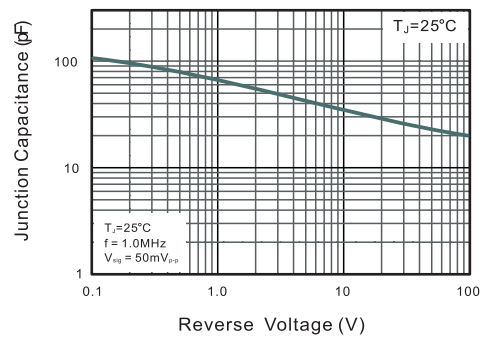
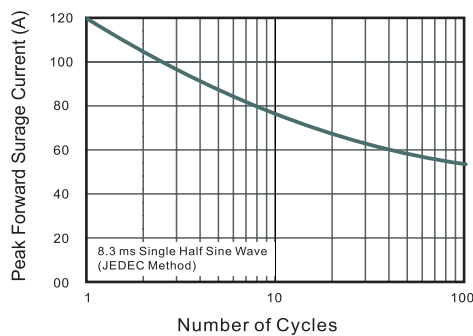

Fig.6 Maximum Non-Repetitive Peak Forward Surge Current



PACKAGE OUTLINE

Plastic surface mounted package; 2 leads

SMC

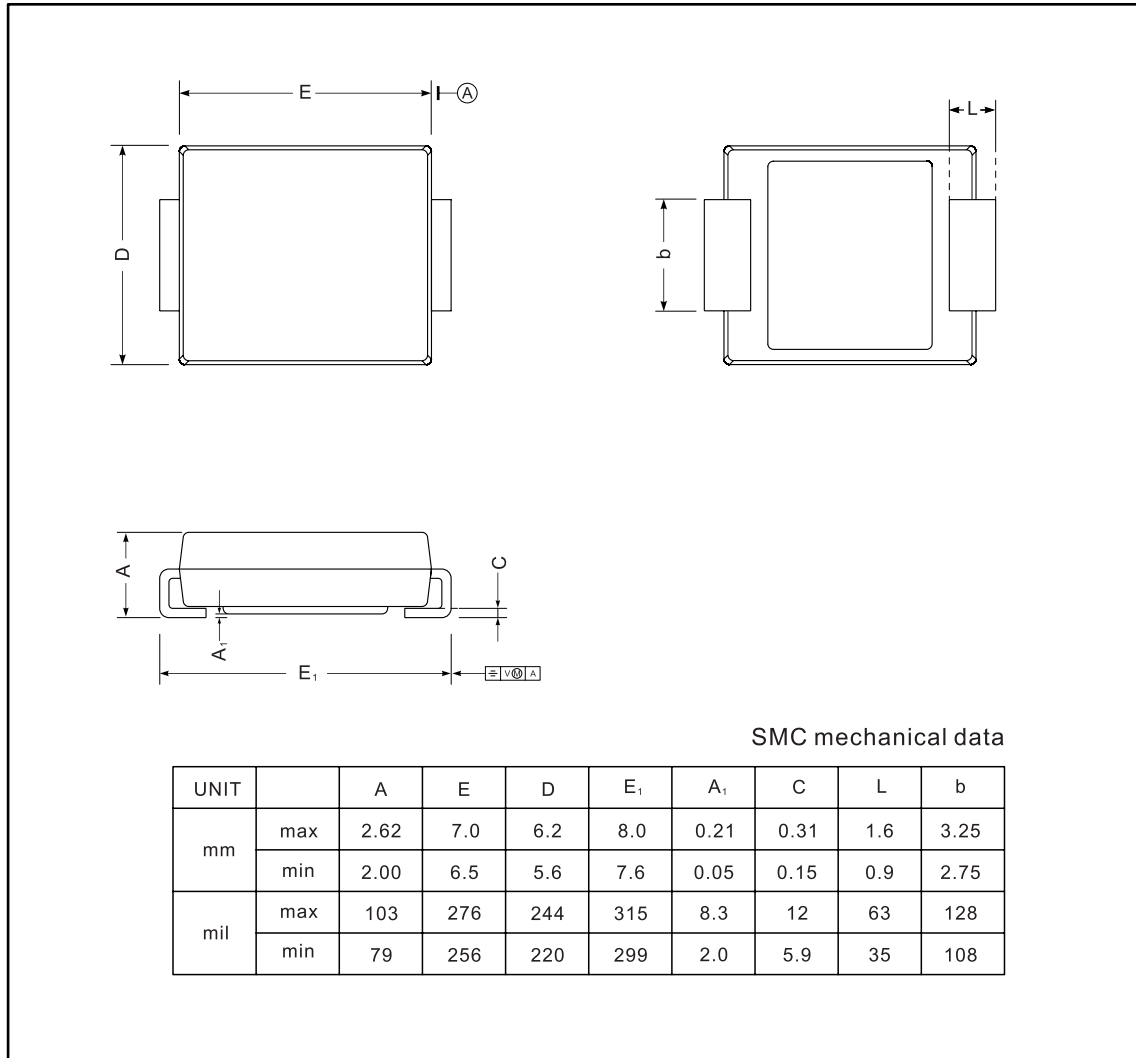

The recommended mounting pad size

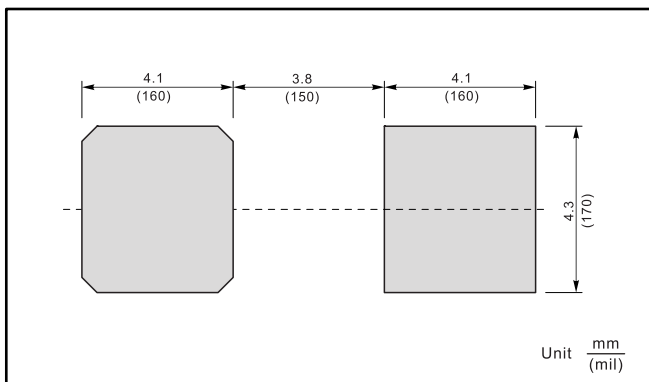

Marking

Type number	Marking code
ES5AC	ES5A
ES5BC	ES5B
ES5CC	ES5C
ES5DC	ES5D
ES5EC	ES5E
ES5GC	ES5G
ES5JC	ES5J