

Single Line Bi-directional Transient Voltage Suppressor

DESCRIPTION

The SD05TC TVS diode is designed to replace multilayer varistors (MLVs) in portable applications such as cell phones, notebooks, and PDA's. It offers superior electrical characteristics such as low clamping voltage, low leakage current and high surge capability. It is designed to protect sensitive electronic components which are connected to power lines, from over-stress caused by ESD (Electrostatic Discharge), EFT (Electrical Fast Transients) and Lighting.

The SD05TC is in a SOD-323 package and will protect one unidirectional line. It may be used to provide ESD protection up to $\pm 30\text{kV}$ (Contact and air discharge) according to IEC61000-4-2, and withstand peak pulse current up to 145A (8/20 μs) according to IEC61000-4-5.

FEATURES

- ✧ Transient protection for high-speed data lines
IEC 61000-4-2 (ESD) $\pm 30\text{kV}$ (Contact)
 $\pm 30\text{kV}$ (Air)
- ✧ Peak power dissipation: 2080W (8/20 μs)
- ✧ Working voltages : 5V
- ✧ Low leakage current
- ✧ Low clamping voltage
- ✧ Solid-state silicon-avalanche technology

MACHANICAL DATA

- ✧ SOD-323 package
- ✧ Flammability Rating: UL 94V-0
- ✧ High temperature soldering guaranteed:
260 $^{\circ}\text{C}$ /10s
- ✧ Packaging: Tape and Reel
- ✧ Reel size: 7 inch

ORDERING INFORMATION

- ✧ Device: SD05TC
- ✧ Package: SOD-323
- ✧ Marking: D5
- ✧ Material: Halogen free and RoHS compliant
- ✧ Packing: Tape & Reel
- ✧ Quantity per reel: 3,000pcs

APPLICATIONS

- ✧ Power lines
- ✧ Personal digital assistants (PDA's)
- ✧ Microprocessors based equipment
- ✧ Notebooks, Desktops, and Servers
- ✧ Cell phone Handsets and Accessories
- ✧ Portable Electronics
- ✧ Peripherals

PIN CONFIGURATION

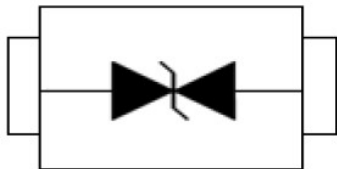

PACKAGE OUTLINE



Single Line Bi-directional Transient Voltage Suppressor

ABSOLUTE MAXIMUM RATING

Symbol	Parameter	Value	Units
V_{ESD}	ESD per IEC 61000-4-2 (Contact)	±30	kV
	ESD per IEC 61000-4-2 (Air)	±30	
P_{PP}	Peak Pulse Power (8/20 μ s)	2080	W
T_{OPT}	Operating Temperature	-55~125	°C
T_{STG}	Storage Temperature	-55~150	°C
T_L	Lead Soldering Temperature	260(10sec)	°C

ELECTRICAL CHARACTERISTICS (Tamb=25°C)

Symbol	Parameter	Test Condition	Min	Typ	Max	Units
V_{RWM}	Reverse Working Voltage				5.0	V
V_{BR}	Reverse Breakdown Voltage	$I_T = 1mA$	5.3		8.0	V
I_R	Reverse Leakage Current	$V_{RWM} = 5.0V$			1	μA
I_{PP}	Peak Pulse Current	$t_p = 8/20\mu s$			130	A
V_C	Clamping Voltage	$I_{PP} = 130A, t_p = 8/20\mu s$			16	V
C_J	Junction Capacitance	$V_R = 0V, f = 1MHz$			450	pF

ELECTRICAL CHARACTERISTICS CURVE

Fig 1 8/20 μ s Waveform per IEC61000-4-5

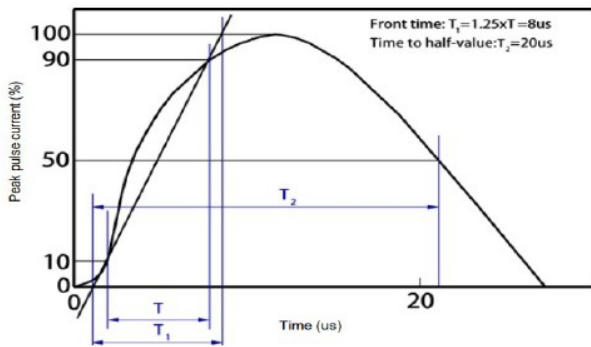

Fig 2 Contact Discharge Current Waveform per IEC 61000-4-2)

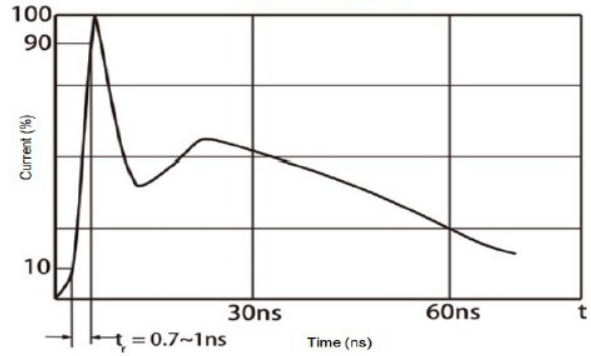

Fig 3 Voltage vs Capacitance

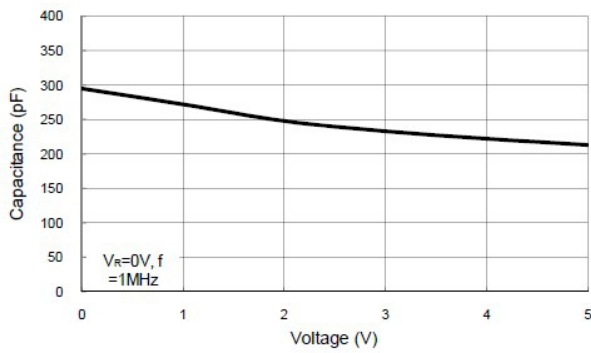
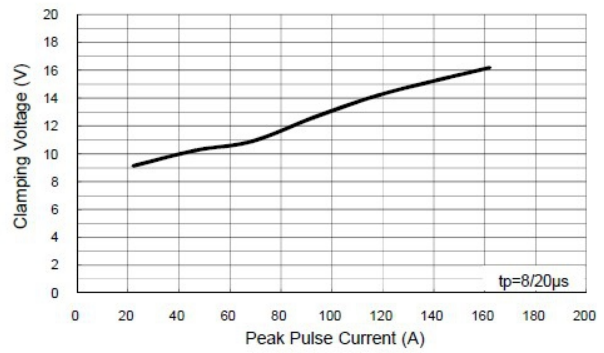
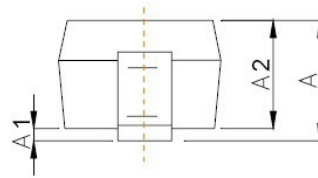
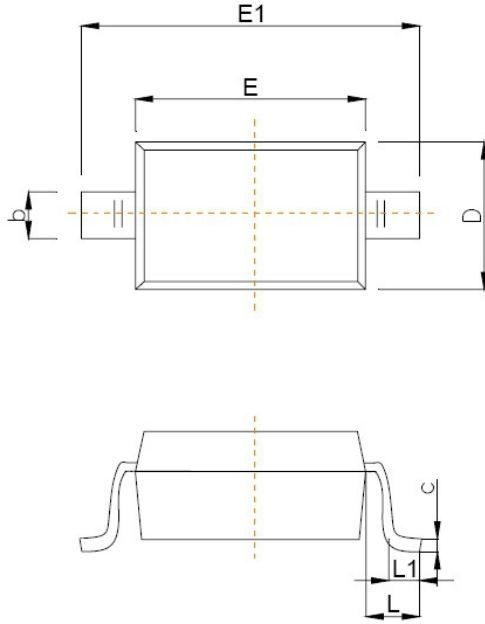

Fig 4 Peak Pulse Current vs Clamping Voltage



SOD-323 PACKAGE OUTLINE DIMENSIONS



Symbol	Dimensions In Millimeters	
	Min	Max
A		1.00
A1	0.000	0.100
A2	0.800	0.900
b	0.250	0.350
c	0.080	0.150
D	1.200	1.400
E	1.600	1.800
E1	2.500	2.700
e	1.800	2.040
L	0.475 REF	
L1	0.250	0.400
θ	0°	8°

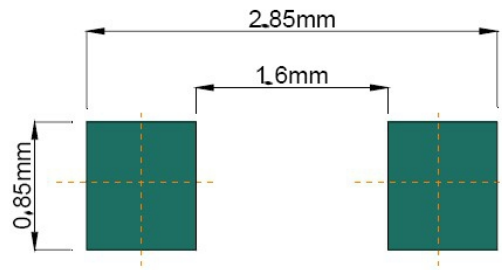

Recommended Pad outline