

DESCRIPTION

The SD07DFMC TVS diode is designed to replace multilayer varistors (MLVs) in portable applications such as cell phones, notebooks, and PDA's. It offers superior electrical characteristics such as low clamping voltage, low leakage current and high surge capability. It is designed to protect sensitive electronic components which are connected to power lines, from over-stress caused by ESD (Electrostatic Discharge), EFT (Electrical Fast Transients) and Lighting.

The SD07DFMC is in a SOD-123FL package and will protect one bidirectional line. It may be used to provide ESD protection up to $\pm 30\text{kV}$ (Contact and air discharge) according to IEC61000-4-2, and withstand peak pulse current up to 200A (8/20 μs) according to IEC61000-4-5.

FEATURES

- ✧ Transient protection for high-speed data lines IEC61000-4-2 (ESD) $\pm 30\text{kV}$ (Contact), $\pm 30\text{kV}$ (Air)
- ✧ Peak power dissipation: 3600W (8/20 μs)
- ✧ Working voltages : 7V
- ✧ Low leakage current
- ✧ Low clamping voltage
- ✧ Solid-state silicon-avalanche technology

MACHANICAL DATA

- ✧ SOD-123FL package
- ✧ Flammability Rating: UL 94V-0
- ✧ High temperature soldering guaranteed: 260 $^{\circ}\text{C}$ /10s
- ✧ Packaging: Tape and Reel
- ✧ Reel size: 7 inch

ORDERING INFORMATION

- ✧ Device: SD07DFMC
- ✧ Package: SOD-123FL
- ✧ Marking: AM.
- ✧ Material: Halogen free and RoHS compliant
- ✧ Packing: Tape & Reel
- ✧ Quantity per reel: 3,000pcs

APPLICATIONS

- ✧ Power lines
- ✧ Personal digital assistants (PDA's)
- ✧ Microprocessors based equipment
- ✧ Notebooks, Desktops, and Servers
- ✧ Cell phone Handsets and Accessories
- ✧ Portable Electronics
- ✧ Peripherals

PIN CONFIGURATION

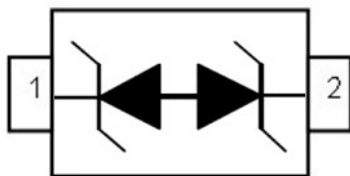

PACKAGE OUTLINE



ABSOLUTE MAXIMUM RATING

Symbol	Parameter	Value	Units
V_{ESD}	ESD per IEC 61000-4-2 (Contact)	±30	kV
	ESD per IEC 61000-4-2 (Air)	±30	
P_{PP}	Peak Pulse Power (8/20μs)	3600	W
T_{OPT}	Operating Temperature	-55~125	°C
T_{STG}	Storage Temperature	-55~150	°C
T_L	Lead Soldering Temperature	260(10sec)	°C

ELECTRICAL CHARACTERISTICS (Tamb=25°C)

Symbol	Parameter	Test Condition	Min	Typ	Max	Units
V_{RWM}	Reverse Working Voltage				7.0	V
V_{BR}	Reverse Breakdown Voltage	$I_T = 1mA$	8.0		10.0	V
I_R	Reverse Leakage Current	$V_{RWM} = 7V$			1.0	μA
I_{PP}	Peak Pulse Current	$t_p = 8/20\mu s$			200	A
V_C	Clamping Voltage	$I_{PP} = 200A, t_p = 8/20\mu s$			18	V
C_J	Junction Capacitance	$V_R = 0V, f = 1MHz$		520	550	pF

ELECTRICAL CHARACTERISTICS CURVE

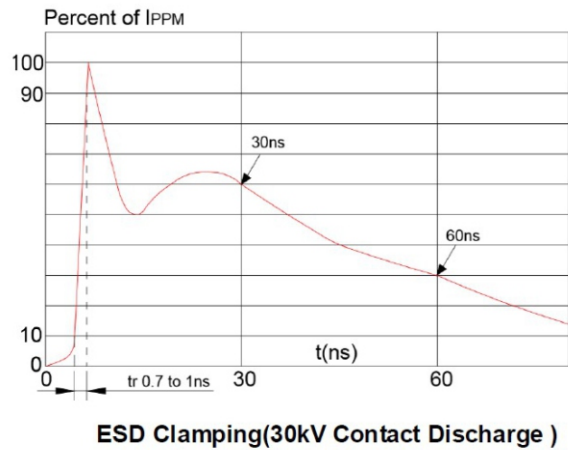
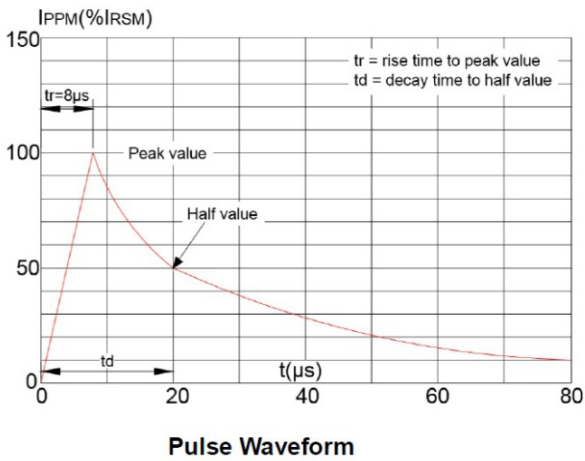
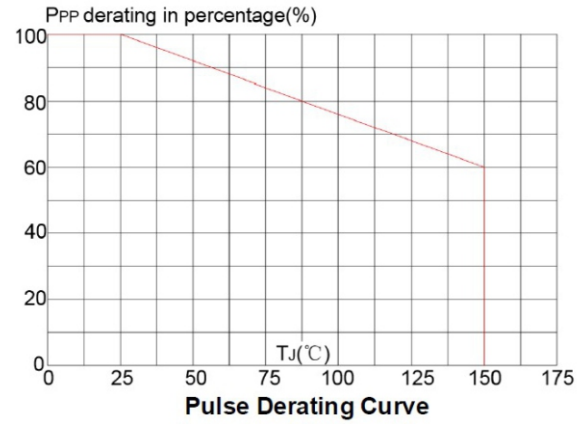
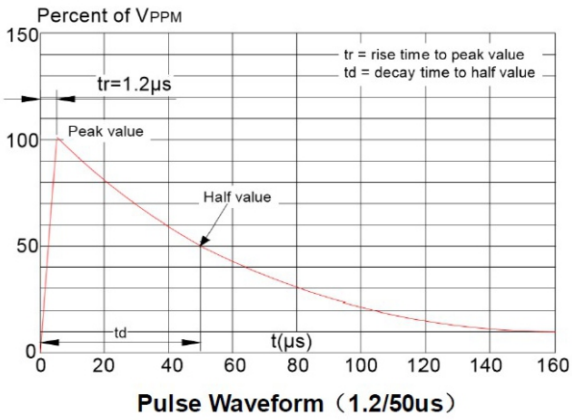

SOD-123FL PACKAGE OUTLINE DIMENSIONS

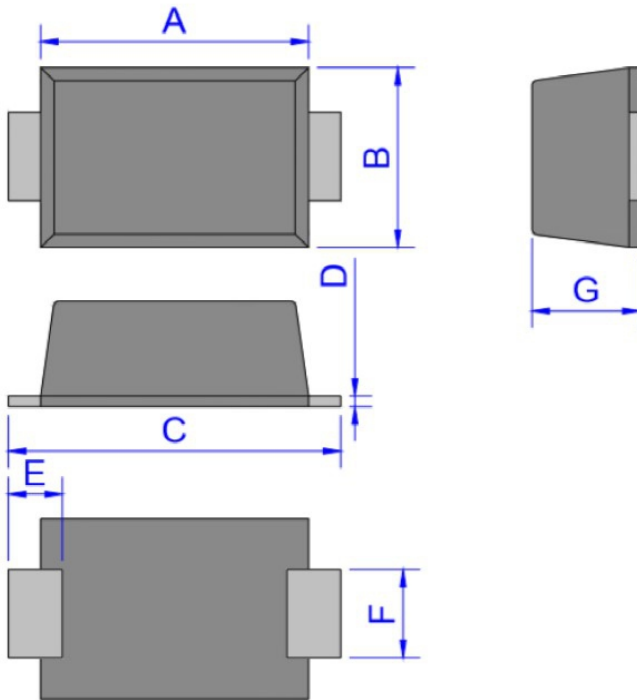

Ref.	Dimensions			
	Millimeters		Inches	
	Min.	Max.	Min.	Max.
A	2.60	3.00	0.102	0.118
B	1.60	2.00	0.063	0.079
C	3.45	3.95	0.136	0.156
D	0.10	0.25	0.004	0.01
E	0.3	0.9	0.012	0.035
F	0.80	1.20	0.031	0.047
G	0.95	1.35	0.037	0.053
J	1.30		0.051	
K		1.70		0.067
L	1.30		0.051	

Recommend Land Pattern (Unit: mm)

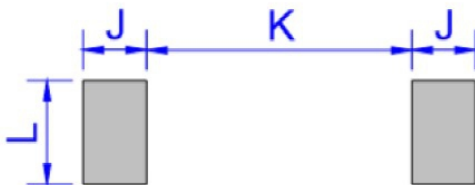

Note:

This recommended land pattern is for reference purpose only.